

BET 10 | Private

The Private Classification units are the smallest units in our product line. These units are often used in country residential and light agricultural applications.

MODEL BET 10

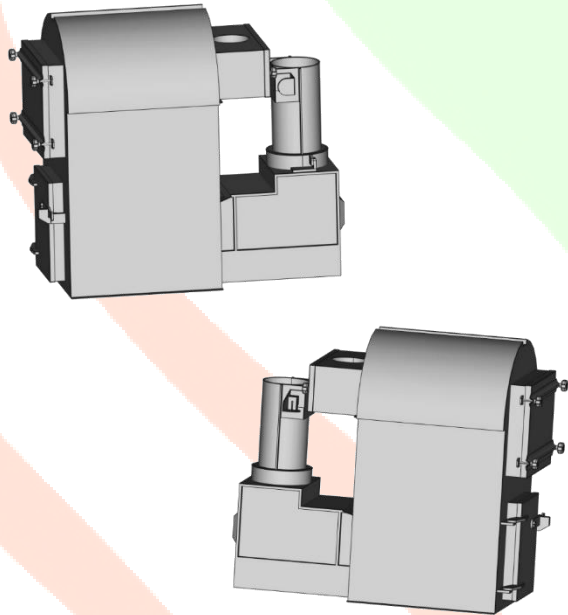

TECHNICAL SPECIFICATIONS:

BTU Output (btu/hr)	225,000
Thermal Energy (kWth)	66
Maximum Consumption (lbs/hr)	48
Maximum Screening Size (in)	1.5
Base Footprint Width (in)	36
Base Footprint Length (in)	65
Application Classification	Private
Operating Temperature (F)	2300°
Gas Retention (seconds)	~2

The BET Technology by BioMass Energy Techniques Inc is currently being used in over 100 applications across North America. This technology has proven versatile and effective on a wide range of feedstocks with high moisture content. Traditionally used to consume wood waste as a fuel feedstock, the basis of the BET system has been proven over many decades in both off-grid and newer leading edge technology applications.

OPTIONAL UPGRADES:

BioChar TakeOut Module with Airlocks	Stainless Steel Package
Touchscreen PLC Controls	Non-Electric Controls
Smart Phone Connectivity	Solar Island Power Source
Remote Monitoring (WiFi/Ethernet)	MicroGen Power Module



BIOMASS ENERGY

TECHNIQUES INC

Toll Free: 1 (888) 828-7637
www.biomassenergytechniques.com
The New Dimension In Renewable Energy